

Sistema: Corredera en línea - PremiLine

Ventajas TécnicasF

■ Ventanas y puertas correderas que permiten grandes superficies acristaladas.

■ Admite un acristalamiento desde 4 mm hasta 28 mm de espesor.

■ Juntas de cepillo y juntas de acristalar PCE integradas desde fábrica.

■ Compatible con todos los sistemas estándar de 70 mm y con el cajón RolaPlus.

■ Fácil integración de acoplamientos existentes, ensanches, alfézares u otros accesorios.

■ Facilidades para el montaje individual en la propia obra.

■ Desplazamiento fácil y silencioso.

■ Diseño atractivo basado en perfiles de hojas con doble biselado.

■ Raíles de acero inoxidable de alta calidad.

■ Galce inclinado para mejor drenaje interior del marco.

■ Puerta estándar con Interlock que mejora la estabilidad con respecto a las puertas habituales.

■ Módulos adicionales para aumentar la inercia. Sección central con manivela deslizante en dos modelos.

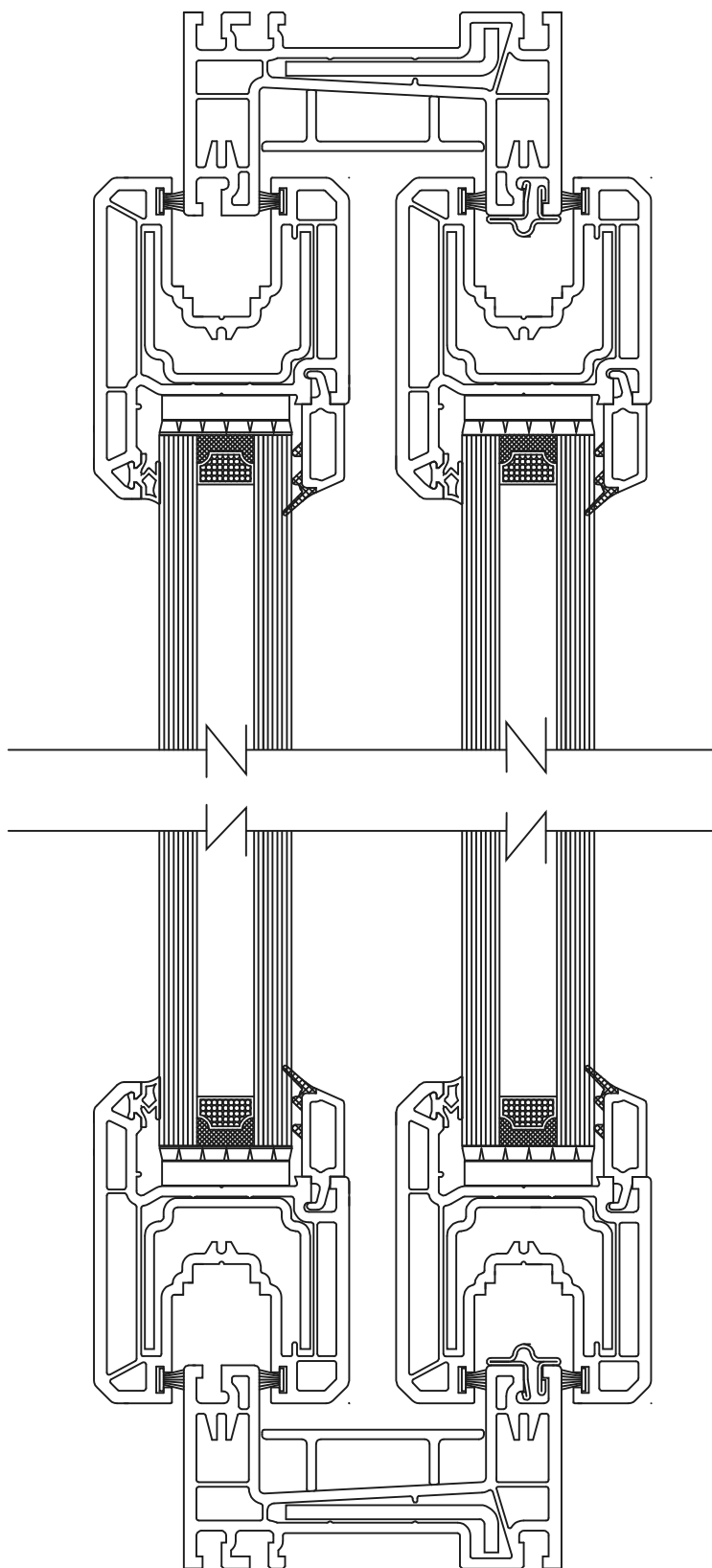

Sistema: Corredera en línea - PremiLine

Perfiles principales - Marcos

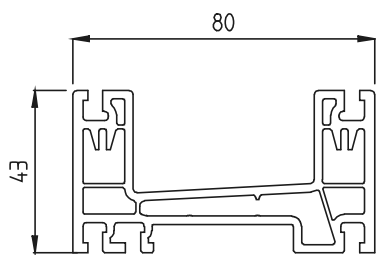

Marco de 49 mm
Art.-Nº. **6050**

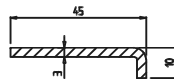

Art.-Nº. **V 110**
 $I_x = 3,0 \text{ cm}^4$

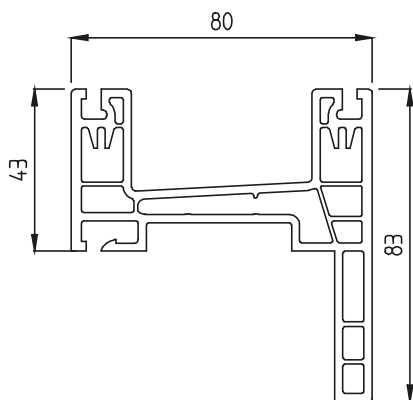

Marco de 43 mm
Art.-Nº. **6051**

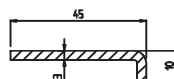

Art.-Nº. **V 110**
 $I_x = 3,0 \text{ cm}^4$

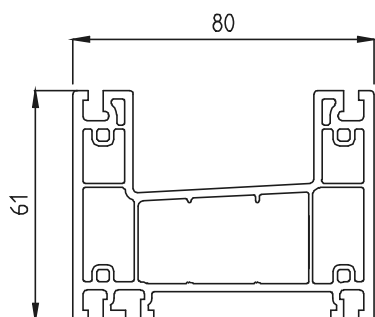

Marco de 61 mm
Art.-Nº. **6052**

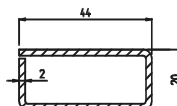

Art.-Nº. **V 107**
 $I_x = 5,3 \text{ cm}^4$

Sistema: Corredera en línea - PremiLine

Perfiles principales - Marcos

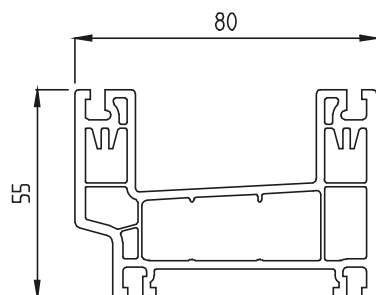

Marco de 55 mm
Art.-Nº. **6054**

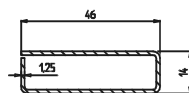

Art.-Nº. **V 108**
 $I_x = 3,3 \text{ cm}^4$

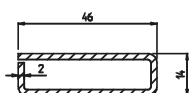

Art.-Nº. **V 109**
 $I_x = 4,8 \text{ cm}^4$

Sistema: Corredera en línea - PremiLine

Perfiles principales - Hojas

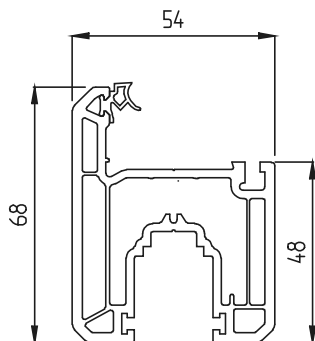

Hoja de 68 mm
Art.-Nº. 6040

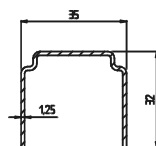

Art.-Nº. V 104
 $I_x = 2,4 \text{ cm}^4$

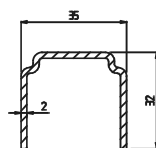

Art.-Nº. V 105
 $I_x = 3,5 \text{ cm}^4$

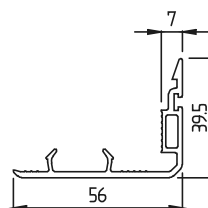

Interlock
Art.-Nº. 6060

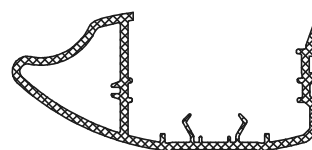

Interlock
Art.-Nº. 9C57

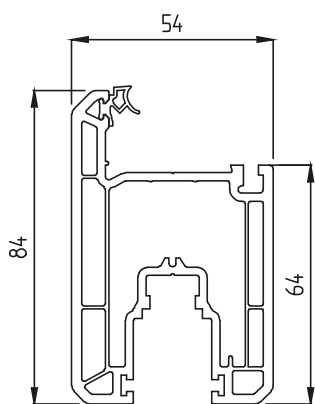

Hoja de 84 mm
Art.-Nº. 6041

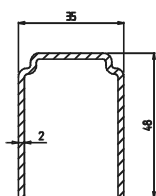

Art.-Nº. V 106
 $I_x = 5,3 \text{ cm}^4$

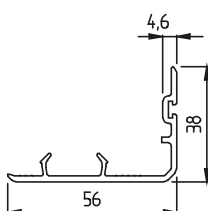

Interlock
Art.-Nº. 6061



Interlock
Art.-Nº. 9C61

Interlock
Art.-Nº. 9C58

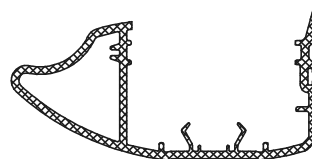

Sistema: Corredera en línea - PremiLine

Perfiles principales - Travesaños

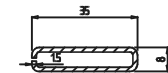
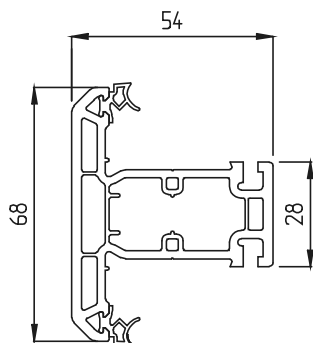

Art.-Nº. V 081
 $I_x = 1,3 \text{ cm}^4$

Travesaño 68 mm
Art.-Nº. **6048**

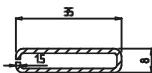
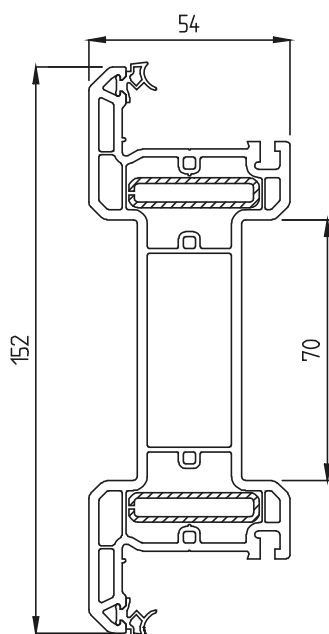

Art.-Nº. V 081
 $I_x = 1,3 \text{ cm}^4$

Travesaño 152 mm
Art.-Nº. **6049**

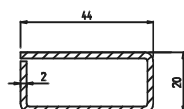
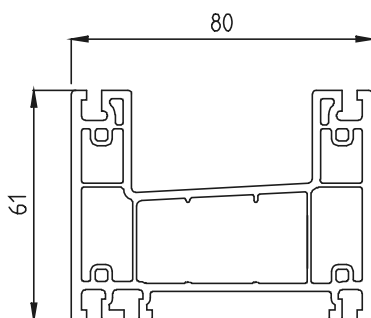

Art.-Nº. V 107
 $I_x = 5,3 \text{ cm}^4$

Travesaño de 61 mm
Art.-Nº. **6052**

Sistema: Corredera en línea - PremiLine

Accesorios



Junta de estanqueidad
Art.-Nº. **9C97**



Junta de estanqueidad
Art.-Nº. **9C49**

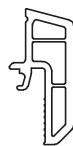

Adaptador de 45 mm
Art.-Nº. **6065**

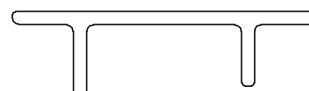

Perfil para drenaje de marcos
Art.-Nº. **6066**

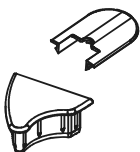

Set de tapas interlocks
Art.-Nº. **9C68**

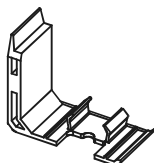

Tapas interlocks
Art.-Nº. **9C59-9C60**



Junta de cepillo para hojas
Art.-Nº. **9090**



Junta de cepillo para guías
Art.-Nº. **9014**



Vierteaguas para correderas
Art.-Nº. **1244**



Perfil de remate
Art.-Nº. **0381**



Perfil de cierre
Art.-Nº. **6067**



Clip para guía
Art.-Nº. **9447**



Carril aluminio
Art.-Nº. **9C51**



Carril acero especial
Art.-Nº. **9C53**

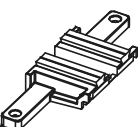

Laberinto
Art.-Nº. **9C64**



Junta para ranura
de marcos
Art.-Nº. **0914**



Carril de aluminio
Art.-Nº. **9C65**



Perfil para clipsado
Art.-Nº. **9B00**



Tornillo autotaladrante
Art.-Nº. **9870**



Tornillo
Art.-Nº. **9419**

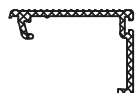

Perfil de cierre.Marco/Hoja
Art.-Nº. **9C62**



Perfil de solera. Aluminio
Art.-Nº. **9C66**

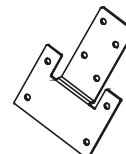

Pieza de unión
Art.-Nº. **9C52**

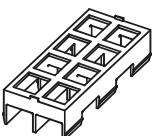

Calce para acristalamiento
de marco
Art.-Nº. **9C55**



Calce para acristalamiento
Art.-Nº. **9C56**

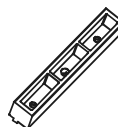

Calce de distancia
Art.-Nº. **9C54**

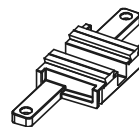

Laberinto
Art.-Nº. **9C63**